









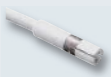

Stecksysteme Connector Systems

Übersicht Overview

Stecksystem Connector system	Farbe Colour		Bemessungsspannung/V Rated voltage/V	Bemessungsstrom/A Rated current/A	max. Leistung/W max. Wattage/W	Schutzklasse Protection class	Anzahl der Pole No. of poles	Durchmesser Stecker Diameter plug	Anwendung Application	ab Seite from page
D8	Weiß White		110-250	2,5	575 (230V)	II	2	7	Netzspannung allgemein; zum Anschluss von Leuchten der Schutzklasse II Mains voltage in general; for connection of luminaires of protection class II	170
D8 codiert D8 coded	Rot Red		110-250	2,5		II	2	7	Codierte Leitung zum Anschluss von Schaltern im Hochvolt-Bereich Coded lead for connection of switches in high voltage range	171
D8.3	Weiß White		110-250	6,0	1380 (230V)	I	3	7,9	Netzspannung allgemein; zum Anschluss von Leuchten der Schutzklasse I Mains voltage in general; for connection of luminaires of protection class I	182
D11.3	Weiß White		110-250	16,0	3680 (230V)	I	3	11	Netzspannung allgemein; zum Anschluss von Leuchten der Schutzklasse I Mains voltage in general; for connection of luminaires of protection class I	184
D8 12V	Blau Blue		12	6,0	72	III	2	7	Niedervolt, z.B. Beleuchtung in der Küche Low voltage, e.g. lighting in the kitchen	180
D8 24V	Grün Green		24	6,0	144	III	2	7	Niedervolt, z.B. Beleuchtung im Ladenbau Low voltage, e.g. lighting in shopfitting	176
D8.4 MIX	Grau Grey		12 24	6,0	72 144	III	3-4	9	Niedervolt, zur Steuerung unserer MIX-Leuchten (Lichtfarbsteuerung 2700-6400K) Low voltage, for control of our MIX luminaires (light colour control 2700-6400K)	186
D8.4 RGB	Pink Pink		24	6,0	144	III	4	9	Niedervolt, zur Steuerung von RGB-Leuchten Low voltage, for control of RGB luminaires	189
ESP	Schwarz Black		12 24	3,0	36 72	III	2		LED-Stecksystem zum Anschluss von konstantstrom- und konstantspannungsgesteuerten Leuchten LED connector system for luminaires operated with constant current or constant voltage	190
C7/C8	Weiß White		230	2,5	575	II	2		Netzspannung allgemein; zum Anschluss von Leuchten der Schutzklasse II Mains voltage in general; for connection of luminaires of protection class II	191

AUF DIE RICHTIGE VERBINDUNG KOMMT ES AN

Erst das passende Stecksystem macht Leuchten zu ganzen Beleuchtungssystemen. Im Programm finden Sie unser ELEKTRA Ministecksystem D8 für 12V, 24V oder 230V, das sich durch besonders große Flexibilität in der Anschlusstechnik auszeichnet. Und natürlich alle weiteren Stecksysteme, ganz Ihren Wünschen entsprechend. Das 4-polige Stecksystem für die Steuerung der Lichtfarben bzw. RGB-Farben finden Sie im ab Seite 186.

THE RIGHT CONNECTION

Only a suitable plug system turns lights into complete lighting systems. In the programme, you will find our ELEKTRA mini-plug system D8 for 12V, 24V or 230V, which is distinguished through especially great flexibility in the connection technology. And naturally, all other plug systems, corresponding completely to your wishes. The 4-pole plug system for the control of light colours and RGB colours can be found from page 186.

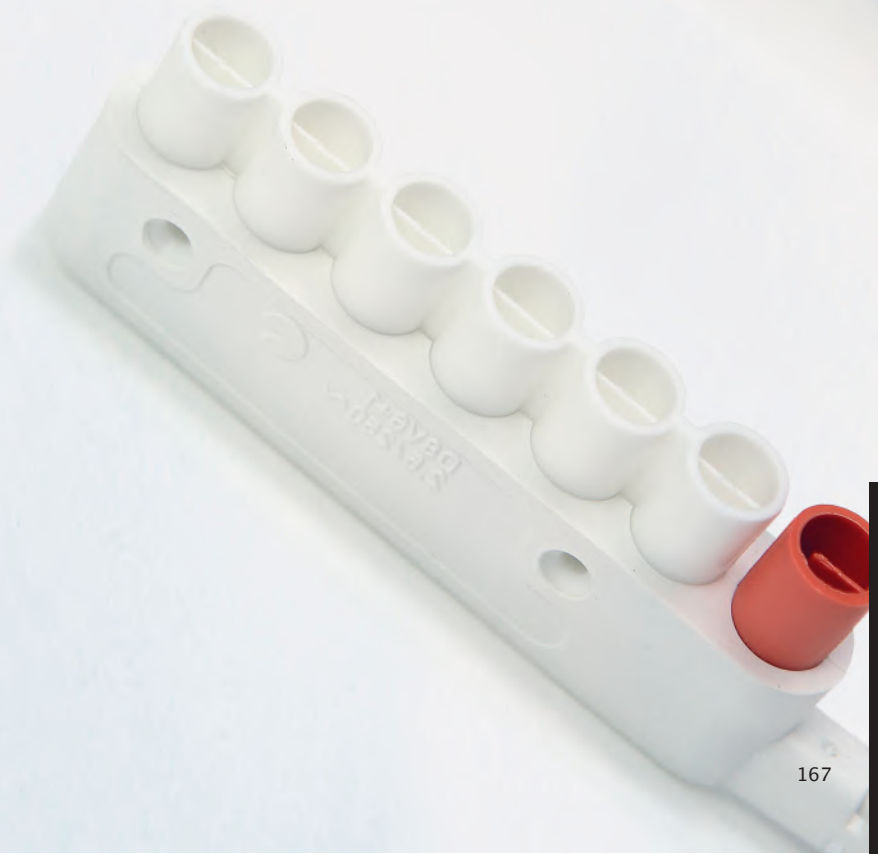

D8 – 230V Ministecksystem Mini connector system

Ministecksystem von ELEKTRA – das Original

Unser Ministecksystem ist patentiert und bekannt für seine sichere und zuverlässige Leistung. Die Handhabung überzeugt durch besondere Benutzerfreundlichkeit: Einfach, schnell und sicher zu montieren!

Eine Vielzahl der ELEKTRA-Produkte kann über das Original Ministecksystem mit lediglich 8mm Bohrdurchmesser kürzester Zeit angeschlossen werden.

Neben dem Ministecksystem hat ELEKTRA noch weitere Stecksysteme im Programm, die speziell für den Anschluss von Niedervolt-LED-Leuchten geeignet sind.

ELEKTRA mini connector system – the original

Our mini connector system is patented and known for its safe and reliable performance. Installation is particularly impressive due to the user-friendliness of the system: Simple, quick and safe to install! A multitude of ELEKTRA products can be connected in the shortest time via the original mini connector system with just 8mm hole diameter.

Alongside the mini connector system, ELEKTRA has other plug and connector systems in the product range that are particularly well suited to the connection of low voltage LED lights.



Abmessungen D8 Dimensions D8
2x0,75mm²

Ministecker Mini male plug

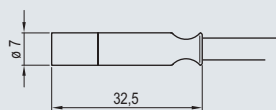

Minibuchse Mini female socket

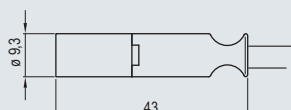

**6-fach Verteiler
+ 1 codierter Ausgang**

**6-way distributor
+ 1 coded outlet**

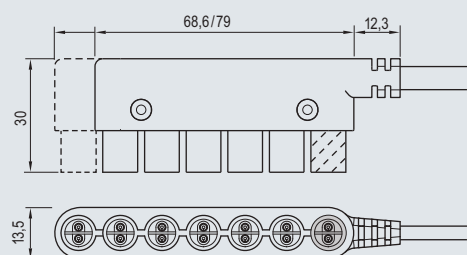

Auf Anfrage sind die Leitungen der Ministecksysteme 230V, 12V, 24V auch in Schwarz erhältlich.

On request the leads of mini connector systems 230V, 12V, 24V are also available in black.

Installationsmöglichkeiten Installation options

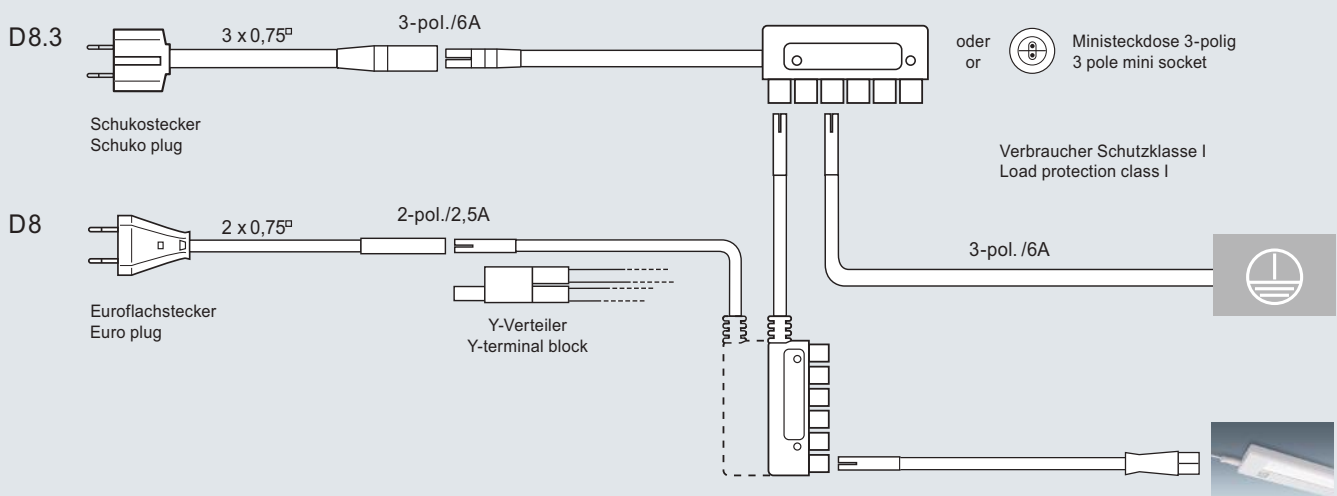
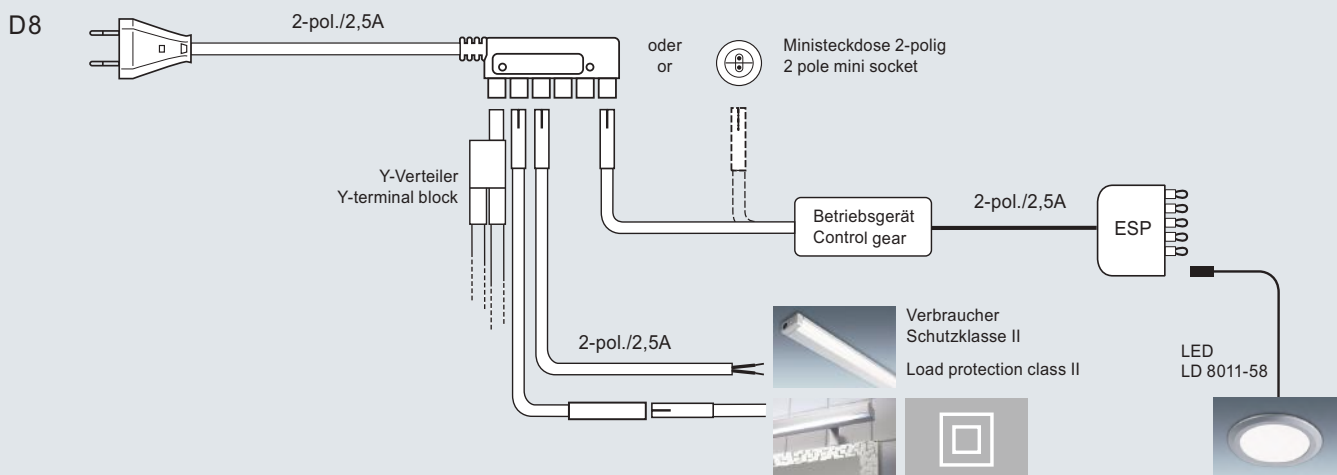
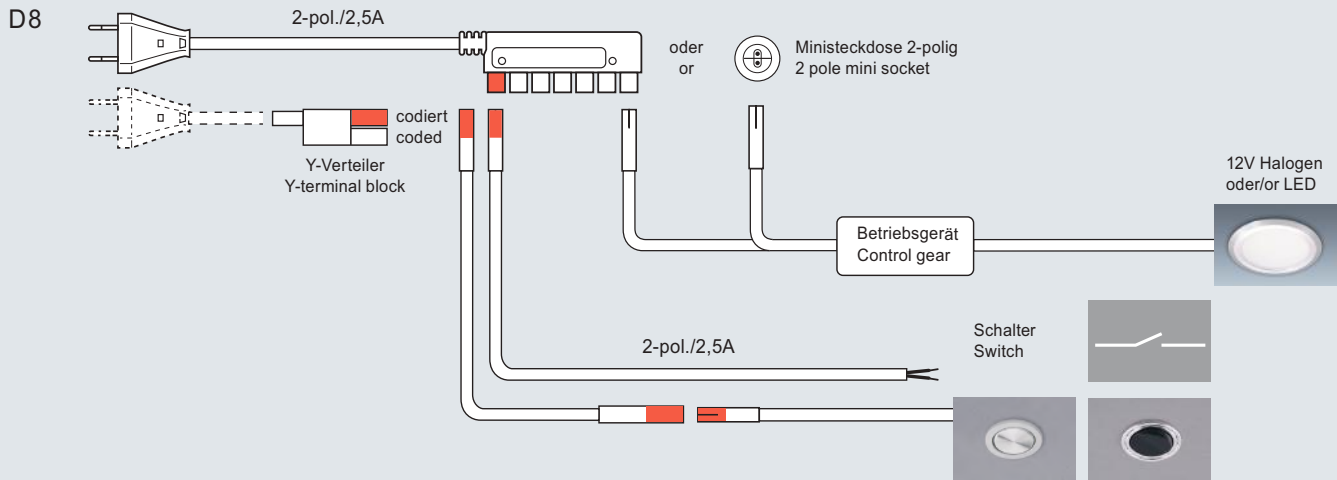

D8 – 230V Ministecksystem Mini connector system



A

Zuleitung

- Euroflachstecker/Minibuchse

Supply lead

- Euro plug/mini female socket

Art.-Nr. Art. No.	Farbe Colour	Länge/mm Length/mm	Gewicht/g Weight/g
531 115 45	weiß white	680	42
531 115 21	weiß white	2000	85
531 115 01	weiß white	3000	116
531 115 50	weiß white	5000	187



B

Zuleitung

- Euroflachstecker/Verteiler 6-fach

Supply lead

- Euro plug/6-way distributor

Art.-Nr. Art. No.	Farbe Colour	Länge /mm Length/mm	Gewicht/g Weight/g
531 116 21	weiß white	2000	110
531 116 01	weiß white	3000	141



C

Verlängerungsleitung

- Ministecker/Verteiler 6-fach

Extension lead

- mini male plug/6-way distributor

Art.-Nr. Art. No.	Farbe Colour	Länge /mm Length/mm	Gewicht/g Weight/g
531 118 02	weiß white	600	48
531 118 01	weiß white	2000	88

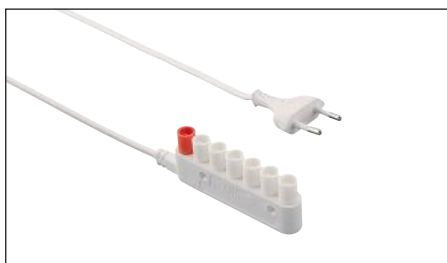

D

Zuleitung

- Euroflachstecker/Verteiler 6-fach codiert für Schalter

Supply lead

- Euro plug/6-way distributor coded for switch

Art.-Nr. Art. No.	Farbe Colour	Länge/mm Length/mm	Gewicht/g Weight/g
531 414 01	weiß white	3500	159

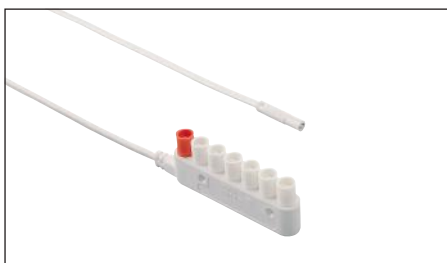

E

Verlängerungsleitung

- 230V 2,5A 2x0,75mm² Ministecker/Verteiler 6-fach codiert für Schalter

Extension lead

- 230V 2,5A 2x0,75mm² mini male plug/6-way distributor coded for switch

Art.-Nr. Art. No.	Farbe Colour	Länge/mm Length/mm	Gewicht/g Weight/g
531 479 01	weiß white	2000	93



F

Verlängerungsleitung

- Ministecker/Minibuchse

Extension lead

- mini male plug/ mini female socket

Art.-Nr. Art. No.	Farbe Colour	Länge/mm Length/mm	Gewicht/g Weight/g
531 111 13	weiß white	150	8
531 111 05	weiß white	230	10
531 111 03	weiß white	295	12
531 111 07	weiß white	500	18
531 111 17	weiß white	700	25
531 111 06	weiß white	1000	36
531 111 02	weiß white	1500	47
531 111 01	weiß white	2000	65
531 111 24	weiß white	3000	95
531 111 12	weiß white	5000	155

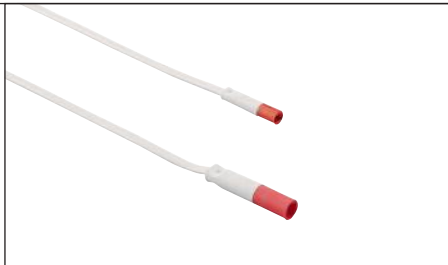

G

Verlängerungsleitung codiert

- Ministecker codiert/Minibuchse codiert

Coded extension lead

- coded mini male plug/coded mini female socket

Art.-Nr. Art. No.	Farbe Colour	Länge /mm Length/mm	Gewicht/g Weight/g
531 112 01	weiß white	2000	63

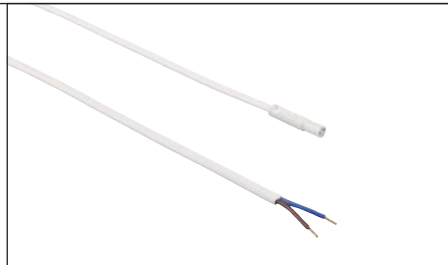

H

Geräte-Anschlussleitung

- Ministecker/Aderendhülsen

Supply lead

- mini male plug/bare ends

Art.-Nr. Art. No.	Farbe Colour	Länge /mm Length/mm	Gewicht/g Weight/g
531 113 42	weiß white	210	8
531 113 51	weiß white	2000	62

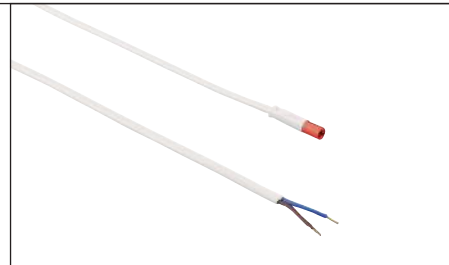

I

Geräte-Anschlussleitung

- Ministecker codiert/Aderendhülsen

Coded supply lead

- coded mini male plug/bare ends

Art.-Nr. Art. No.	Farbe Colour	Länge /mm Length/mm	Gewicht/g Weight/g
531 114 06	weiß white	2000	64



J

Zuleitung mit Winkelbuchse

- Euroflachstecker/Miniwinkelbuchse
- nur für Adapter der Stromschiene Macro

Supply lead with angled socket

- Euro plug/mini female angled socket
- only for adapter of Macro electrical track

Art.-Nr. Art. No.	Farbe Colour	Länge /mm Length/mm	Gewicht/g Weight/g
532 674 01	weiß white	2000 horizontal	87
532 673 01	weiß white	3000 vertical	117



K

Verlängerungsleitung mit Winkelbuchse

- Ministecker/Miniwinkelbuchse
- nur für Adapter der Stromschiene Macro

Extension lead with angled socket

- mini male plug/mini female
- only for adapter of Macro electrical track

Art.-Nr. Art. No.	Farbe Colour	Länge /mm Length/mm	Gewicht/g Weight/g
532 674 02	weiß white	2000 horizontal	66
532 673 02	weiß white	2000 vertical	66



L

Anschlussleitung mit Winkelstecker

- horizontaler oder vertikaler Anschluss, Miniwinkelstecker/Aderendhülsen
- nur für Adapter der Stromschiene Macro

Supply lead with angled plug

- horizontal or vertical installation, with mini male angled plug/bare ends
- only for adapter of Macro electrical track

Art.-Nr. Art. No.	Farbe Colour	Länge /mm Length/mm	Gewicht/g Weight/g
532 671 01	weiß white	2000 vertikal	65
532 672 01	weiß white	2000 horizontal	65



Schlitz im Gehäuse parallel zur Leitung
Slot in connector parallel to the cable



Schlitz im Gehäuse quer zur Leitung
Slot in connector transverse to the cable



D8 – 230V Ministecksystem Mini connector system



M

Adapterleitung C7/C8 → D8

- Buchse C7/Ministecker

Adapter lead C7/C8 → D8

- female socket C7/mini male plug

Art.-Nr. Art. No.	Farbe Colour	Länge/mm Length/mm	Gewicht/g Weight/g
531 113 21	weiß white	2000	70



N

Adapterleitung D8 → C7/C8

- Minibuchse D8/Stecker C7/C8

Adapter lead D8 → C7/C8

- female socket D8/plug C7/C8

Art.-Nr. Art. No.	Farbe Colour	Länge/mm Length/mm	Gewicht/g Weight/g
531 115 57	weiß white	500	32
531 115 69	weiß white	245	19



O

Direktverbinder für LD 8010 A

- Adapter für bündige Lichtbandmontage

Direct connector for LD 8010 A

- direct connector for flush continuous row mounting

Art.-Nr. Art. No.	Farbe Colour	Länge/mm Length/mm	Gewicht/g Weight/g
529 685 01	weiß white	45	2



P

Direktverbinder für TL 2001 und LD 8021 A

- Adapter für bündige Lichtbandmontage

Direct connector for TL 2001 and LD 8021 A

- direct connector for flush continuous row mounting

Art.-Nr. Art. No.	Farbe Colour	Länge/mm Length/mm	Gewicht/g Weight/g
529 685 02	weiß white	88	6



Q

Y-Verteiler

- Ministecker/2-fach Verteiler

Y-distributor

- with mini male plug 2-way distributor

Art.-Nr. Art. No.	Farbe Colour	Länge/mm Length/mm	Gewicht/g Weight/g
529 753 02	weiß white	52	10



R

Y-Verteiler codiert

- Ministecker/2-fach Verteiler mit einer codierten Buchse für Schalter

Coded Y-distributor

- mini male plug/2-way distributor with one coded outlet for switch

Art.-Nr. Art. No.	Farbe Colour	Länge/mm Length/mm	Gewicht/g Weight/g
529 753 01	weiß white	52	10



S

Blindstopfen

- Schutz für freie Buchsen aller 2-poligen Miniverteiler
5 Stck.

Closing plug

- protection for free female outlets of all 2-pole mini distributors
5 pcs

Art.-Nr. Art. No.	Farbe Colour	Länge/mm Length/mm	Gewicht/g Weight/g
540 151 38	weiß white		2



T

Adapterleitung

- Euroflachkupplung/Ministecker

Adapter lead

- Euro socket/mini male plug

Art.-Nr. Art. No.	Farbe Colour	Länge/mm Length/mm	Gewicht/g Weight/g
531 301 03	weiß white	200	17
531 301 04	weiß white	300	26
531 301 05	weiß white	400	35



U

Ministeckdose Ø 20mm

- für 2-poligen Ministecker 230V
inkl. Leitung mit Ministecker

Mini socket Ø 20mm

- for 2-pole mini male plug 230V
incl. lead with mini male plug

Art.-Nr. Art. No.	Farbe Colour	Länge/mm Length/mm	Gewicht/g Weight/g
529 853 01	weiß white	2000	72



V

Gehäuse für Ministeckdose

- Einbaubuchse und Mutter für Ministeckdose 2-polig, ohne Leitung

Housing for mini socket

- housing and nut for 2-pole mini socket, without lead

Art.-Nr. Art. No.	Farbe Colour	Länge/mm Length/mm	Gewicht/g Weight/g
529 853 99	weiß white		7
529 853 98	schwarz black		7



W

Ministeckdose Ø 12mm

- für 2-poligen Ministecker 230V
inkl. fest angeschlossener
Leitung mit Ministecker

Mini socket Ø 12mm

- for 2-pole mini male plug 230V
incl. fixed lead with mini
male plug

Art.-Nr. Art. No.	Farbe Colour	Länge/mm Length/mm	Gewicht/g Weight/g
524 956 01	weiß white	800	80



X

Dichtungsstüle IP44

- Spritzwasserschutz passend für alle D8-Ministecksysteme;
Silikon transparent

Sealing grommet IP44

- splash protection for all mini connector systems D8;
transparent silicone

Art.-Nr. Art. No.	Farbe Colour	Länge/mm Length/mm	Gewicht/g Weight/g
540 153 14	transparent	30	2

Halogenfreie Leitungen **2-polig 2,5A** **Schutzklasse II**

Halogenfreie Leitungen enthalten kein Chlor, Fluor, Brom oder Jod. In einem Brandfall entstehen deshalb keine korrosiven oder toxischen Gase, außerdem sind die Rauchentwicklung und die Brandlast nur gering.

Korrosionsschäden durch Gase, die bei der Verbrennung halogenhaltiger Leitungen meist höher sind als die eigentlichen Brandschäden, können durch halogenfreie Leitungen minimiert werden.

Deshalb eignen sich halogenfreie Leitungen besonders für den Einsatz in öffentlichen Gebäuden (Flughäfen, Warenhäusern, Hotels, Bahnanlagen, etc.) oder im Schiffsbau.

Halogen-free cables **2-pole 2,5A** **Protection class II**

Halogen-free cables do not contain chlorine, fluorine, bromine or iodine. In case of fire corrosive or toxic gases will not be released. Furthermore, generation of smoke and the fire load is low.

Corrosive damage caused by gases that are generated during combustion of halogenated cables is usually larger than the fire damage itself. Usage of halogen-free cables will reduce this damage.

For that reason, halogen-free cables are specifically suitable for use in public buildings (airports, department stores, mass transit stations and vehicles etc.) or in shipbuilding.



A

Zuleitung halogenfrei

- Euroflachstecker/Minibuchse

Supply lead halogen-free

- Euro plug/mini female socket

Art.-Nr. Art. No.	Farbe Colour	Länge/mm Length/mm	Gewicht/g Weight/g
524 354 02	weiß white	2000	85
524 354 01	weiß white	3000	116



B

Zuleitung/Verteiler 6-fach halogenfrei

- Euroflachstecker/Verteiler 6-fach

Supply lead halogen-free

- Euro plug/6-way distributor

Art.-Nr. Art. No.	Farbe Colour	Länge/mm Length/mm	Gewicht/g Weight/g
524 356 02	weiß white	2000	117
524 356 01	weiß white	3000	165



C

Verlängerungsleitung halogenfrei

- Ministecker/Minibuchse

Extension lead halogen-free

- mini male plug/mini female socket

Art.-Nr. Art. No.	Farbe Colour	Länge/mm Length/mm	Gewicht/g Weight/g
524 350 01	weiß white	295	13
524 350 02	weiß white	500	22
524 350 03	weiß white	1000	32
524 350 07	weiß white	1500	40
524 350 04	weiß white	2000	48



D

Direktverbinder halogenfrei

- Adapter für bündige Lichtbandmontage der Leuchte LD 8021 A

Direct connector halogen-free

- direct connector for flush continuous row mounting of luminaire LD 8021 A

Art.-Nr. Art. No.	Farbe Colour	Länge/mm Length/mm	Gewicht/g Weight/g
529 685 02	weiß white	88	6

D8 - 24V LED-Ministecksystem LED mini connector system

Installationsmöglichkeiten Installation options

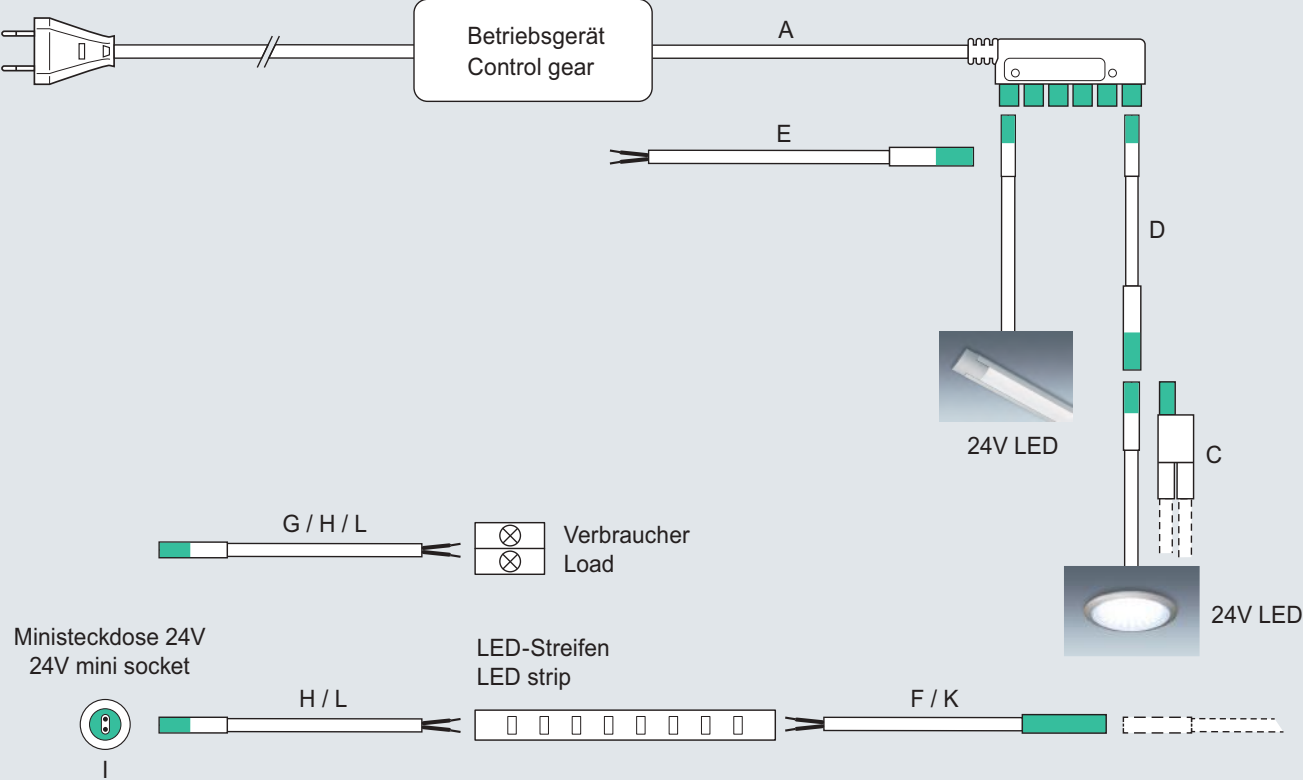

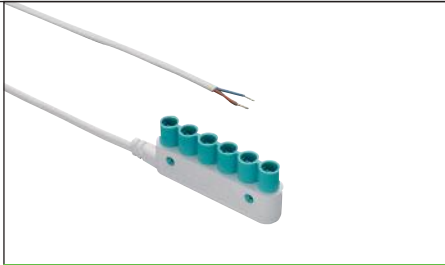

A

Zuleitung

- Aderendhülsen/Verteiler 6-fach

Supply lead

- bare ends/6-way distributor

Art.-Nr. Art. No.	Farbe Colour	Länge/mm Length/mm	Gewicht/g Weight/g
529 918 01	weiß white	155	32
529 918 02	weiß white	335	45
529 918 06	weiß white	1000	60
529 918 07	weiß white	1500	66

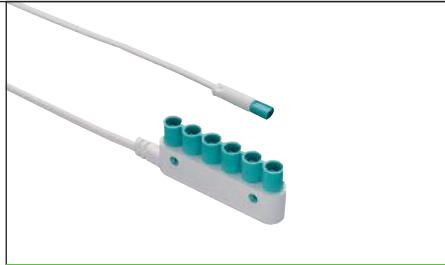

B

Zuleitung

- Ministecker/Verteiler 6-fach

Supply lead

- mini male plug/6-way distributor

Art.-Nr. Art. No.	Farbe Colour	Länge/mm Length/mm	Gewicht/g Weight/g
529 918 03	weiß white	155	33



C

Y-Verteiler

- Ministecker/2-fach Verteiler

Y-distributor

- mini male plug/2-way distributor

Art.-Nr. Art. No.	Farbe Colour	Länge/mm Length/mm	Gewicht/g Weight/g
529 753 22	weiß white	52	10

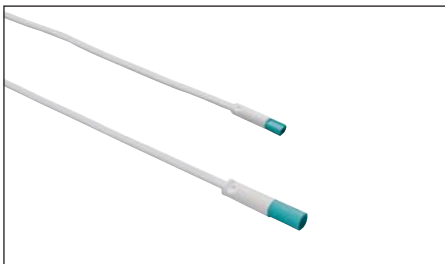

D

Verlängerungsleitung

- Ministecker/Minibuchse

Extension lead

- Mini male plug/mini female socket

Art.-Nr. Art. No.	Farbe Colour	Länge/mm Length/mm	Gewicht/g Weight/g
529 919 09	weiß white	250	14
529 919 06	weiß white	500	20
529 919 03	weiß white	700	25
529 919 02	weiß white	1000	34
529 919 08	weiß white	1500	42
529 919 01	weiß white	2000	66
529 919 05	weiß white	2500	82
529 919 04	weiß white	3000	98

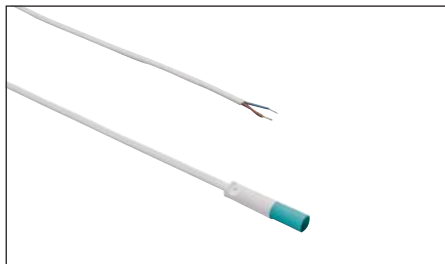

E

Zuleitung

- Minibuchse/Aderendhülsen

Supply lead

- Mini female socket/bare ends

Art.-Nr. Art. No.	Farbe Colour	Länge/mm Length/mm	Gewicht/g Weight/g
529 917 13	weiß white	150	6
529 917 02	weiß white	220	8
529 917 04	weiß white	290	12
529 917 07	weiß white	1000	33

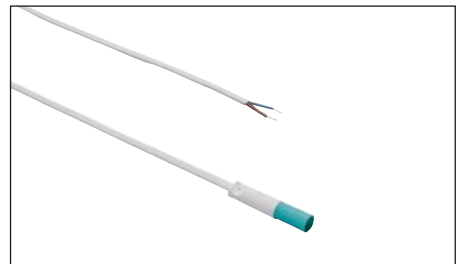

F

Zuleitung

- Minibuchse/verzinnte Enden

Supply lead

- Mini female socket/tinned ends

Art.-Nr. Art. No.	Farbe Colour	Länge/mm Length/mm	Gewicht/g Weight/g
529 917 09	weiß white	150	6
529 917 08	weiß white	500	18
529 917 20	weiß white	850	26
529 917 05	weiß white	1000	33
529 917 10	weiß white	2000	42

D8 - 24V LED-Ministecksystem LED mini connector system

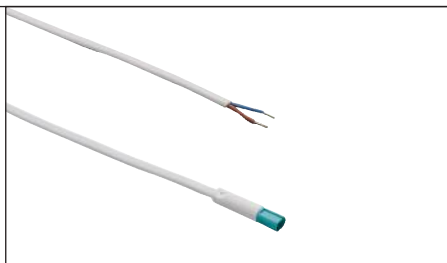

G

Anschlussleitung

- Ministecker/Aderendhülsen

Supply lead

- Mini male plug/bare ends

Art.-Nr. Art. No.	Farbe Colour	Länge/mm Length/mm	Gewicht/g Weight/g
529 916 35	weiß white	100	4
529 916 34	weiß white	2000	69

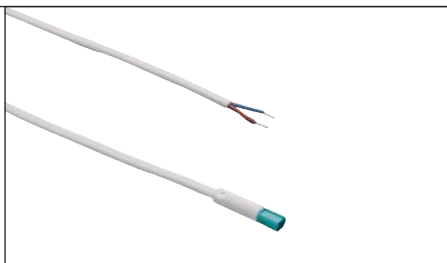

H

Anschlussleitung

- Ministecker/verzinnte Enden

Supply lead

- Mini male plug/tinned ends

Art.-Nr. Art. No.	Farbe Colour	Länge/mm Length/mm	Gewicht/g Weight/g
529 916 02	weiß white	150	6
529 916 40	weiß white	290	9
529 916 03	weiß white	400	12
529 916 41	weiß white	850	24
529 916 29	weiß white	1000	35
529 916 01	weiß white	2000	42



I

Ministeckdose

- Ministecker/Ministeckdose

Mini socket

- Mini male plug/mini socket

Art.-Nr. Art. No.	Farbe Colour	Länge/mm Length/mm	Gewicht/g Weight/g
529 894 01	weiß white	1000	62

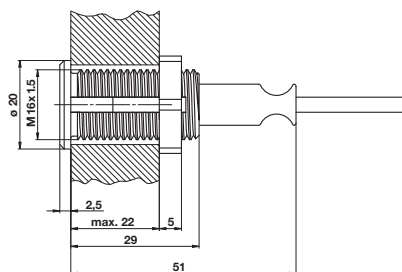

J

Gehäuse für Ministeckdose

- passend zu Leitung D

Housing for mini socket

- suitable for lead D

Art.-Nr. Art. No.	Farbe Colour	Gewicht/g Weight/g
529 853 99	weiß white	7
529 853 98	schwarz black	7

D8 – 24V mit Zwillingsleitungen 2-polig, 6A, Schutzklasse III

Die Zwillingsleitung ist eine zweiadrige flexible Leitung zur Verwendung bei sehr geringen mechanischen Beanspruchungen, zum Beispiel in Leuchten.

D8–24V with twin leads 2-pole, 6A, protection class III

The twin line cable is a two-wired flexible lead for use with very low mechanical stresses, for example in luminaires.



Abmessungen D8 24V Dimensions D8 24V
2x0,5mm²

Ministecker mit Zwillingsleitung
Mini male plug with twin lead

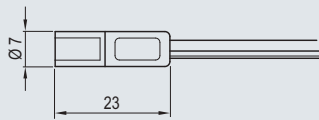

Minibuchse mit Zwillingsleitung
Mini female socket with twin lead

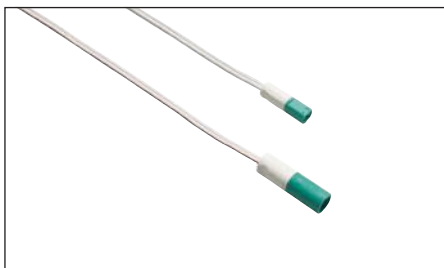
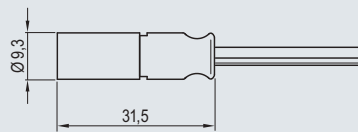

A

Verlängerungsleitung

- Ministecker/Minibuchse

Extension lead

- mini male plug/mini female socket

Art.-Nr. Art. No.	Farbe Colour	Länge/mm Length/mm	Gewicht/g Weight/g
538 342 01	weiß white	500	11
538 342 02	weiß white	1000	18
538 342 05	weiß white	1500	25
538 342 03	weiß white	2000	33

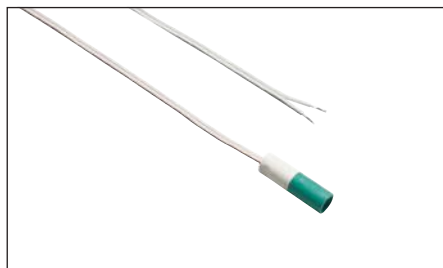

B

Zuleitung

- Minibuchse/verzinnte Enden

Supply lead

- mini female socket/tinned ends

Art.-Nr. Art. No.	Farbe Colour	Länge/mm Length/mm	Gewicht/g Weight/g
538 344 01	weiß white	70	3
538 344 03	weiß white	100	4
538 344 02	weiß white	150	5
538 344 08	weiß white	200	7
538 344 06	weiß white	500	12

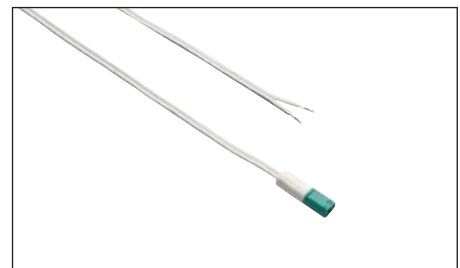

C

Anschlussleitung

- Ministecker/verzinnte Enden

Supply lead

- mini male plug/tinned ends

Art.-Nr. Art. No.	Farbe Colour	Länge/mm Length/mm	Gewicht/g Weight/g
538 343 03	weiß white	60	2
538 343 04	weiß white	150	3
538 343 01	weiß white	1000	16
538 343 09	weiß white	1500	22
538 343 02	weiß white	2000	31

D8 - 12V LED-Minstecksystem LED mini connector system

Installationsmöglichkeiten Installation options

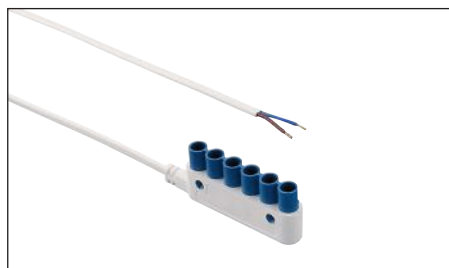
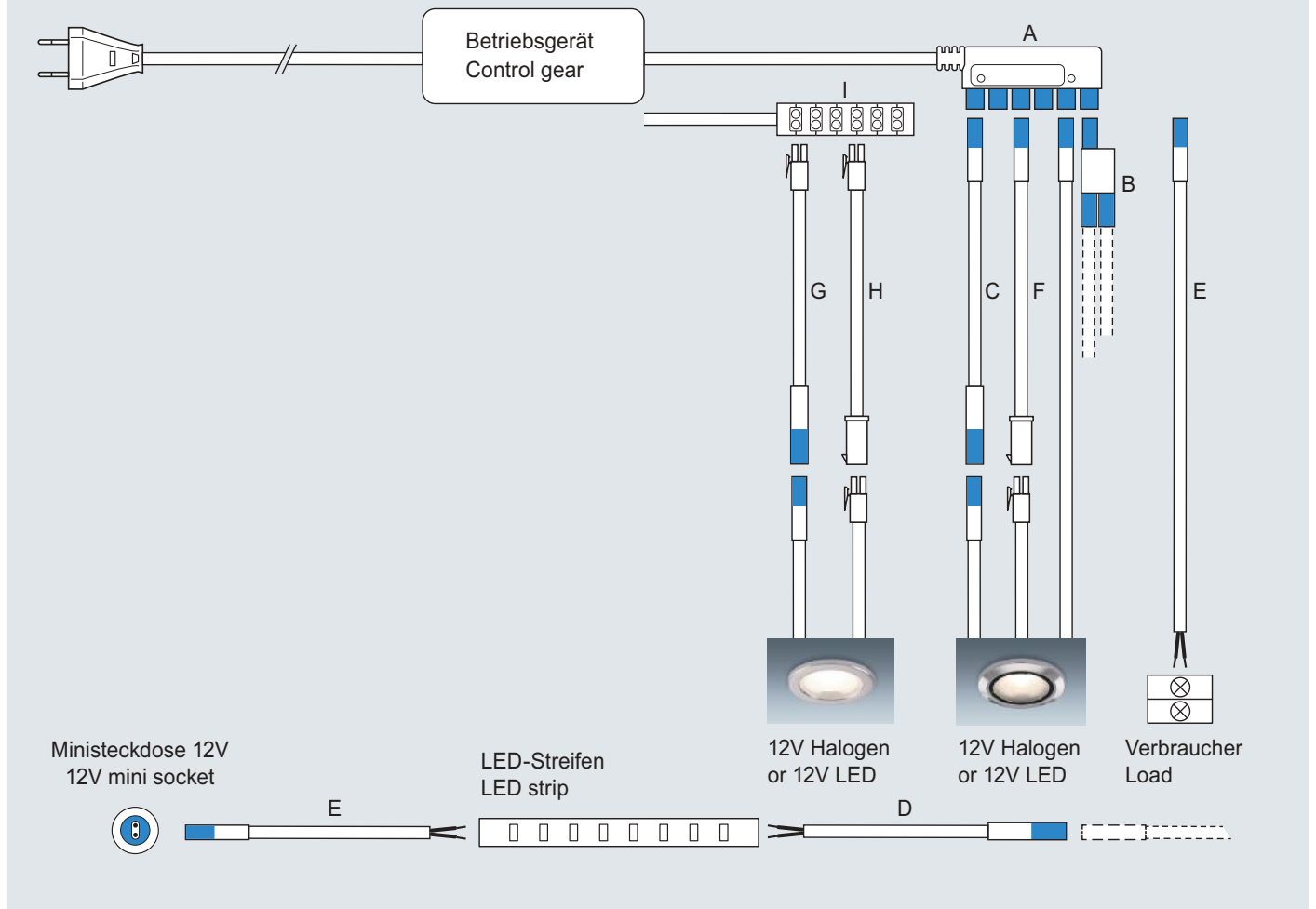

A

Zuleitung

- Aderendhülsen/Verteiler 6-fach

Supply lead

- Bare ends/6-way distributor

Art.-Nr. Art. No.	Farbe Colour	Länge/mm Length/mm	Gewicht/g Weight/g
531 710 02	weiß white	155	32

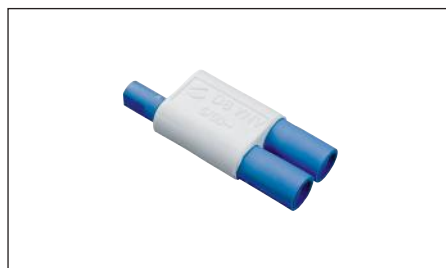

B

Y-Verteiler

- Ministecker/2-fach Verteiler

Y-distributor

- mini male plug/2-way distributor

Art.-Nr. Art. No.	Farbe Colour	Länge/mm Length/mm	Gewicht/g Weight/g
529 753 12	weiß white	52	10

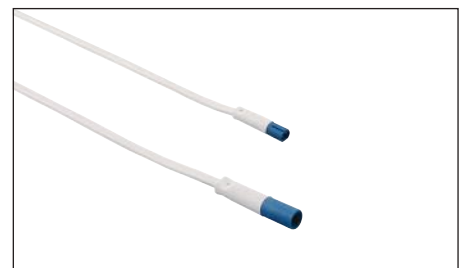

C

Verlängerungsleitung

- Ministecker/Minibuchse

Extension lead

- Mini male plug/mini female socket

Art.-Nr. Art. No.	Farbe Colour	Länge/mm Length/mm	Gewicht/g Weight/g
531 707 02	weiß white	1000	34
531 707 01	weiß white	2000	65
531 707 03	weiß white	3000	94



D

Zuleitung

- Minibuchse/verzinnte Enden

Supply lead

- Mini female socket/tinned ends

Art.-Nr. Art. No.	Farbe Colour	Länge/mm Length/mm	Gewicht/g Weight/g
531 709 01	weiß white	150	8
531 709 06	weiß white	500	17



E

Anschlussleitung

- Ministecker/verzinnte Enden

Supply lead

- Mini male plug/tinned ends

Art.-Nr. Art. No.	Farbe Colour	Länge/mm Length/mm	Gewicht/g Weight/g
531 708 19	weiß white	100	4
531 708 22	weiß white	1000	33
531 708 06	weiß white	2000	61



F

Adapterleitung

- Buchse AMP/Ministecker

Adapter lead

- AMP female socket/mini male plug

Art.-Nr. Art. No.	Farbe Colour	Länge/mm Length/mm	Gewicht/g Weight/g
531 708 99	weiß white	Length/mm	5
531 708 98	weiß white	2000	70

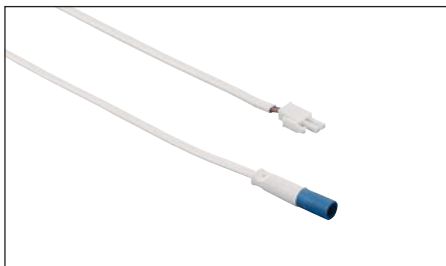

G

Adapterleitung

- Minibuchse/AMP Stecker

Adapter lead

- Mini female socket/AMP male plug

Art.-Nr. Art. No.	Farbe Colour	Länge/mm Length/mm	Gewicht/g Weight/g
531 709 99	weiß white	120	7



H

Verlängerungsleitung

- AMP Buchse/AMP Stecker

Extension lead

- AMP female socket/AMP male plug

Art.-Nr. Art. No.	Farbe Colour	Länge/mm Length/mm	Gewicht/g Weight/g
510 849 01	schwarz black	1000	42
510 849 11	weiß white	1000	41
510 849 02	schwarz black	2000	82
510 849 22	weiß white	2000	81

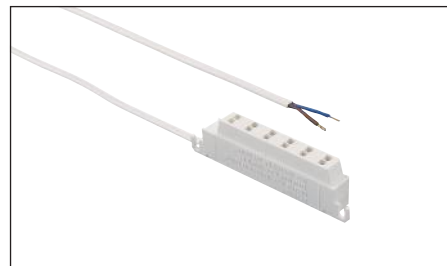

I

Verteiler

- AMP Verteiler/Aderendhülsen max. 10A Gesamtbelastung, 3A pro Stecker

Distributor

- Mini male plug/mini socket max. 10A total load, 3A per outlet

Art.-Nr. Art. No.	Farbe Colour	Länge/mm Length/mm	Gewicht/g Weight/g
522 090 02	weiß white	5-fach/way; 155	23
522 090 01	weiß white	6-fach/way; 155	23

D8.3 – 230V Ministecksystem Mini connector system



Abmessungen D8.3 Dimensions D8.3
3x0,75mm²

Stecker Male plug

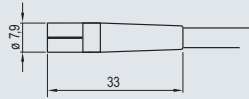

Buchse Female socket

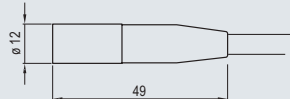

6-fach Verteiler 6-way distributor

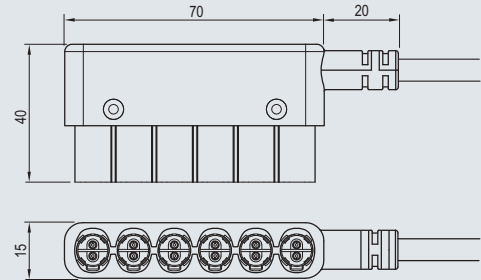

System D8.3 = 250V, 3-polig, max. 6A
 Zum Anschluss von Verbrauchern der Schutzklasse I (max. 6A).

System D8.3 = 250V, 3-pole, 6A max.
 Suitable for the supply of loads of protection class I (6A max).



A

Zuleitung

- Aderendhülsen/Minibuchse

Supply lead

- Bare ends/mini female socket

Art.-Nr. Art. No.	Farbe Colour	Länge/mm Length/mm	Gewicht/g Weight/g
529 841 01	weiß white	1000	56
529 841 02	weiß white	2000	102
529 841 03	weiß white	3000	148



B

Zuleitung

- Schuko-Winkelstecker/
Minibuchse

Supply lead

- angled Schuko plug/
mini female socket

Art.-Nr. Art. No.	Farbe Colour	Länge/mm Length/mm	Gewicht/g Weight/g
529 841 04	weiß white	1000	165
529 841 05	weiß white	2000	235
529 841 06	weiß white	3000	260



C

**Zuleitung/Verteiler 6-fach
10A**

- Aderendhülsen/Verteiler 6-fach
für Verbraucher der Schutzklasse I

**Supply lead/6-way distributor
10A**

- mini male plug/6-way distributor
for fixtures protection class I

Art.-Nr. Art. No.	Farbe Colour	Länge/mm Length/mm	Gewicht/g Weight/g
529 842 07	weiß white	500	66
529 842 03	weiß white	1000	90
529 842 08	weiß white	2000	141



D

**Zuleitung/Verteiler 6-fach
10A**

- Schukostecker/Verteiler 6-fach für Verbraucher der Schutzklasse I

**Supply lead/6-way distributor
10A**

- Schuko plug/coded 6-way distributor for fixtures protection class I

Art.-Nr. Art. No.	Farbe Colour	Länge/mm Length/mm	Gewicht/g Weight/g
529 842 04	weiß white	500	114
529 842 05	weiß white	1000	140
529 842 06	weiß white	2000	166
529 842 01	weiß white	3000	192



E

**Verlängerungsleitung/
Verteiler 6-fach**

- Ministecker/Verteiler 6-fach für Verbraucher der Schutzklasse I

**Extension lead
6-way distributor**

- Mini male plug/6-way distributor for fixtures protectionj class I

Art.-Nr. Art. No.	Farbe Colour	Länge/mm Length/mm	Gewicht/g Weight/g
529 842 09	weiß white	500	104
529 842 02	weiß white	2000	143



F

Verlängerungsleitung

- Minibuchse/Ministecker

Extension lead

- mini male plug/Mini female socket

Art.-Nr. Art. No.	Farbe Colour	Länge/mm Length/mm	Gewicht/g Weight/g
529 843 07	weiß white	500	23
529 843 01	weiß white	1000	56
529 843 06	weiß white	1500	83
529 843 02	weiß white	2000	103
529 843 03	weiß white	3000	153
529 843 04	weiß white	4000	212
529 843 05	weiß white	5000	254



G

Geräte-Anschlussleitung

- Aderendhülsen/Ministecker für Verbraucher der Schutzklasse I

Supply lead

- Bare ends/mini male plug for fixtures protection class I

Art.-Nr. Art. No.	Farbe Colour	Länge/mm Length/mm	Gewicht/g Weight/g
529 840 01	weiß white	500	20
529 840 07	weiß white	1000	51
529 840 03	weiß white	2000	98
529 840 05	weiß white	3000	147



H

Ministeckdose

- Ministecker/Ministeckdose 3-polig

Mini socket

- Mini male plug/3-pole mini socket

Art.-Nr. Art. No.	Farbe Colour	Länge/mm Length/mm	Gewicht/g Weight/g
529 686 01	weiß white	2000	63
529 686 99	weiß white	Gehäuse	9



Gehäuse für Ministeckdose auch einzeln zu Leitung F lieferbar, siehe Seite 173.

Housing for mini socket separately available for lead F, see page 173.



I

Y-Verteiler

- Ministecker/Verteiler 2-fach

Y-distributor

- Mini male plug/2-way distributor

Art.-Nr. Art. No.	Farbe Colour	Länge/mm Length/mm	Gewicht/g Weight/g
529 753 32	weiß white	76	19

D11.3 – 230V Ministecksystem Mini connector system



Abmessungen D11.3 Dimensions D11.3
3x 1,5mm²

Stecker Male plug

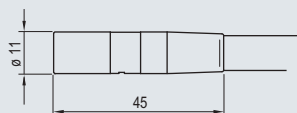

Buchse Female socket

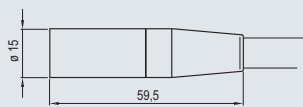

6-fach Verteiler 6-way distributor

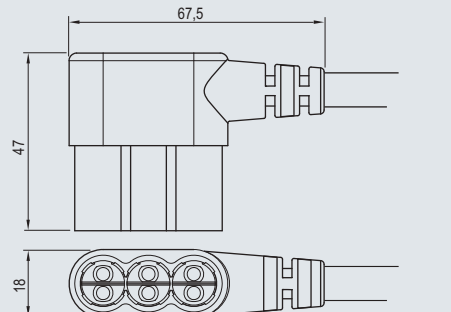

System D11.3 = 250V, 3-polig, max. 16A
 Zum Anschluss von Verbrauchern der Schutzklasse I
 (max. 16A) wie z.B. Leuchten aus Metall.

System D11.3 = 250V, 3-pole, 16A max.
 Suitable for the supply of loads of protection class I
 (16A max) like ie. metal luminaires.



A

Zuleitung

- Aderendhülsen/Minibuchse

Supply lead

- Bare ends/mini female socket



B

Zuleitung

- Schuko-Winkelstecker/
Minibuchse

Supply lead

- angled Schuko plug/
mini female socket



C

Zuleitung/Verteiler 3-fach

- Aderendhülsen/Verteiler 3-fach
für Verbraucher der Schutz-
klasse I (max. 16 A pro Stecker)
- Schraubbefestigung

Supply lead/3-way distributor

- mini male plug/6-way distri-
butor for fixtures protection
class I (16 A max. per plug)
- screw fixing

Art.-Nr. Art. No.	Farbe Colour	Länge/mm Length/mm	Gewicht/g Weight/g
524 369 01	weiß white	500	125
524 369 02	weiß white	1000	165
524 369 03	weiß white	2000	211

Art.-Nr. Art. No.	Farbe Colour	Länge/mm Length/mm	Gewicht/g Weight/g
524 369 04	weiß white	500	185
524 369 05	weiß white	1000	255
524 369 06	weiß white	2000	275

Art.-Nr. Art. No.	Farbe Colour	Länge/mm Length/mm	Gewicht/g Weight/g
524 370 07	weiß white	500	80
524 370 08	weiß white	1000	110
524 370 09	weiß white	2000	155



D

Zuleitung/Verteiler 3-fach

- Schukostecker/Verteiler 3-fach für Verbraucher der Schutzklasse I (max. 16 A pro Stecker)
- Schraubbefestigung

Supply lead/3-way distributor

- Schuko plug/coded 3-way distributor for fixtures protection class I (16 A max. per plug)
- screw fixing

Art.-Nr. Art. No.	Farbe Colour	Länge/mm Length/mm	Gewicht/g Weight/g
524 370 04	weiß white	500	125
524 370 05	weiß white	1000	155
524 370 06	weiß white	2000	180



E

**Verlängerungsleitung/
Verteiler 3-fach**

- Ministecker/Verteiler 3-fach für Verbraucher der Schutzklasse I (max. 16 A pro Stecker)
- Schraubbefestigung

**Extension lead
3-way distributor**

- Mini male plug/3-way distributor for fixtures protection class I (16 A max. per plug)
- screw fixing

Art.-Nr. Art. No.	Farbe Colour	Länge/mm Length/mm	Gewicht/g Weight/g
524 370 01	weiß white	500	105
524 370 02	weiß white	1000	155
524 370 03	weiß white	2000	250



F

Verlängerungsleitung

- Minibuchse/Ministecker

Extension lead

- mini male plug/mini female socket

Art.-Nr. Art. No.	Farbe Colour	Länge/mm Length/mm	Gewicht/g Weight/g
524 371 01	weiß white	500	60
524 371 02	weiß white	1000	110
524 371 03	weiß white	2000	215



G

Geräte-Anschlussleitung

- Aderendhülsen/Ministecker
- für Verbraucher der Schutzklasse I

Supply lead

- bare ends/mini male plug
- for fixtures protection class I

Art.-Nr. Art. No.	Farbe Colour	Länge/mm Length/mm	Gewicht/g Weight/g
524 368 01	weiß white	500	55
524 368 02	weiß white	1000	100
524 368 03	weiß white	2000	198

**Verbindung von System
D11.3 (16A) zu D8.3 (6A)**

**Connection of system
D11.3 (16A) to D8.3 (6A)**



H

**Verlängerungsleitung/
Verteiler 6-fach**

- Ministecker D11.3/6-fach Verteiler D8.3 für Verbraucher der Schutzklasse I (max. 6A pro Stecker)
- Schraubbefestigung

**Extension lead
6-way distributor**

- mini male plug D11.3/6-way distributor D8.3 for fixtures protection class I (6A max. per plug)
- screw fixing

Art.-Nr. Art. No.	Farbe Colour	Länge/mm Length/mm	Gewicht/g Weight/g
524 372 01	weiß white	500	95
524 372 02	weiß white	1000	145
524 372 03	weiß white	2000	205

D8.4 – MIX Ministecksystem MIX Mini connector system

Abmessungen MIX und RGB
4x0,5mm² / 2x0,5mm²

Dimensions MIX and RGB
4x0,5mm² / 2x0,5mm²

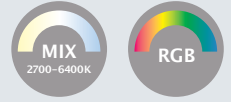

Stecker Male plug

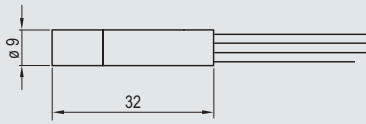

Buchse Female socket

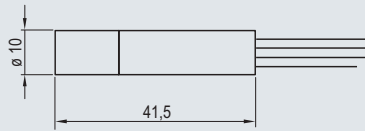

3-fach Schaltverstärker
3-way Amplifier

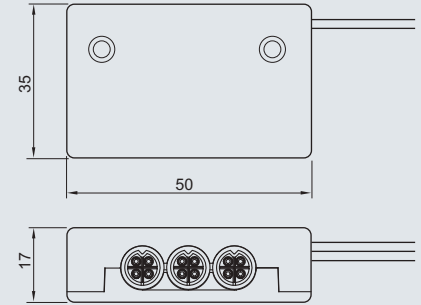

6-fach Verteiler 6-way distributor

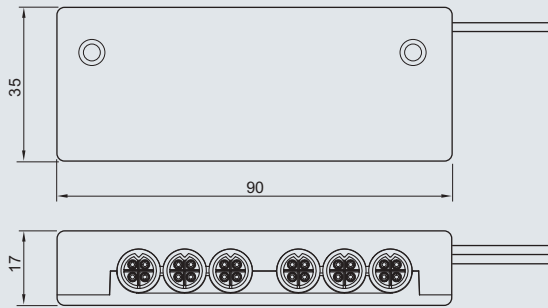

4-/3-poliges LED-Stecksystem zum Anschluss von Leuchten mit MIX-Lichtfarbsteuerung (grau) oder für RGB-Farbsteuerung (pink)

4-/3-pole LED connector system for installation of luminaires with MIX tunable colour temperature (grey) or for RGB colour control (pink).

Installationsmöglichkeiten
Installation options



Maximale Anschlussleistung:
Maximum supply power:
12V = 72W
24V = 144W

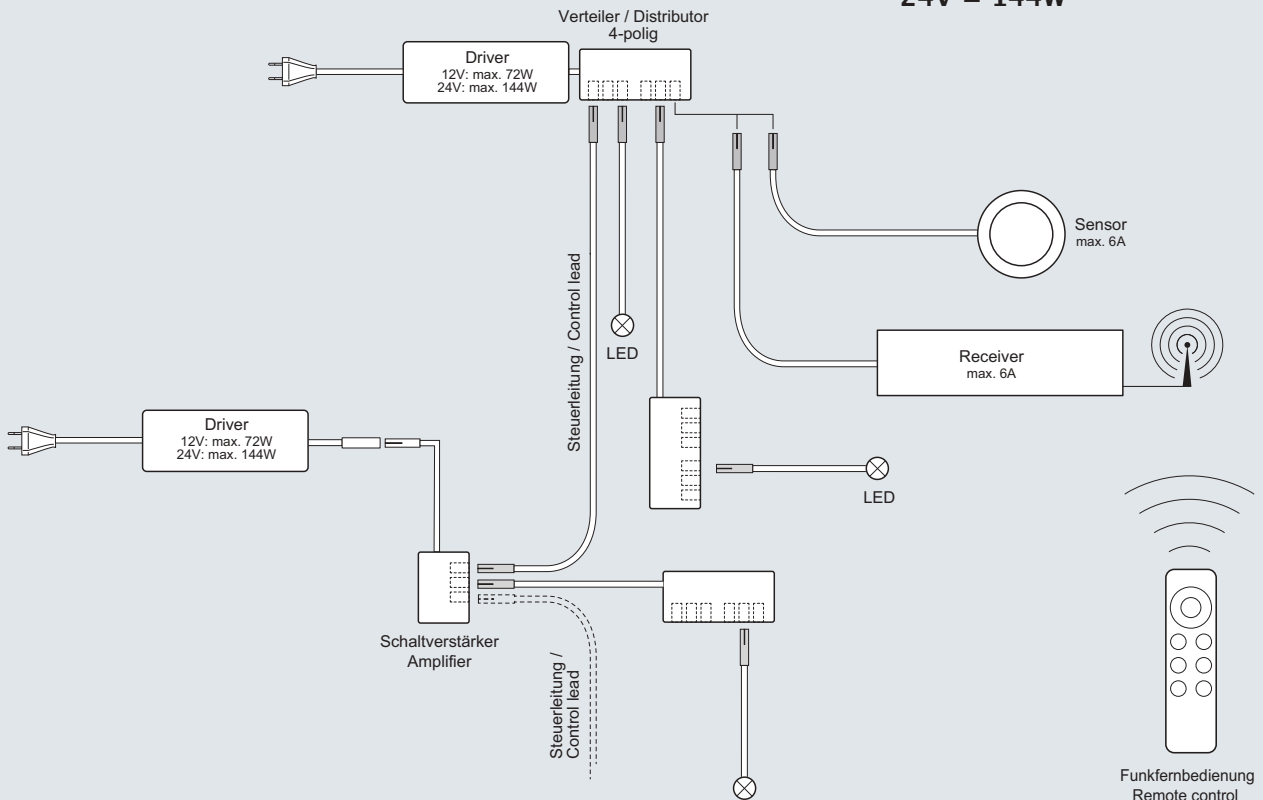



MIX A

**Verteiler 6-fach
max. 6A**

- 155 mm Flachbandleitung
- wahlweise mit
 - Ministecker 12V
 - Ministecker 24V
 - Ministecker 4-polig
 - ESP-Stecker 12-24V
 - Aderendhülsen

**6-way distributor
6A max.**

- 155 mm flat ribbon lead
- optionally with
 - mini male plug 12V
 - mini male plug 24V
 - mini male plug 4-pole
 - ESP plug 12-24V
 - bare ends

Art.-Nr. Art. No.	Ausführung Type	Gewicht/g Weight/g
538 908 01	Ministecker 12V Mini male plug 12V	47
538 908 02	Ministecker 24V Mini male plug 24V	47
538 910 01	Ministecker 4-polig Mini male plug 4-pole	52
538 903 01	Stecker ESP 12-24V Plug ESP 12-24V	43
538 908 04	Aderendhülsen Bare ends	40



MIX B

**Schaltverstärker 3-fach
max. 6A**

- 3-fach Verteiler 4-polig
- 190 mm Flachbandleitung
- wahlweise mit
 - Ministecker 12V
 - Ministecker 24V
 - ESP-Stecker 12-24V

**3-way Amplifier
6A max.**

- 3-way distributor 4-pole
- 190 mm flat ribbon lead
- optionally with
 - mini male plug 12V
 - mini male plug 24V
 - ESP plug 12-24V

Art.-Nr. Art. No.	Ausführung Type	Gewicht/g Weight/g
538 909 01	Ministecker 12V Mini male plug 12V	28
538 909 02	Ministecker 24V Mini male plug 24V	28
538 904 01	Stecker ESP 12-24V Plug ESP 12-24V	25

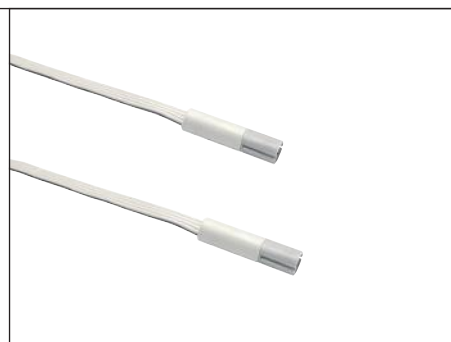

MIX C

Steuerleitung

- Ministecker/Ministecker mit Flachbandleitung

Control lead

- mini male resp. mini male plug with flat ribbon lead

Art.-Nr. Art. No.	Länge/mm Length/mm	Gewicht/g Weight/g
538 900 01	1000	34
538 900 02	2000	38



Funkfernbedienung und Empfänger für das MIX-System siehe Kapitel Steuerungen ab Seite 140.



Remote control and receiver for the MIX system see chapter Controls from page 140.

D8.4 – MIX Ministecksystem MIX Mini connector system



MIX D

Anschlussleitung max. 6A

- Ministecker/verzinnte Enden mit Flachbandleitung

Supply lead 6A max.

- mini male resp. tinned ends with flat ribbon lead

Art.-Nr. Art. No.	Länge/mm Length/mm	Gewicht/g Weight/g
538 901 02	400	10
538 901 01	1800	65
538 901 04	3000	95



MIX E

Verlängerungsleitung max. 6A

- Ministecker/Minibuchse mit Flachbandleitung

Extension lead 6A max.

- mini male resp. mini female socket with flat ribbon lead

Art.-Nr. Art. No.	Länge/mm Length/mm	Gewicht/g Weight/g
538 905 01	1000	45
538 905 02	2000	62



MIX F

LED-Driver Konstantspannung inkl. Verteiler 6-fach 100–240V 50/60Hz

- 12V max. 50W
- 24V max. 75W
- pri.: 3000 mm Leitung mit Euroflachstecker
- sek.: 340 mm Leitung mit 6-fach Verteiler 4-polig

Constant voltage LED driver incl. 6-way distributor 100–240V 50/60Hz

- 12V 50W max.
- 24V 75W max.
- pri.: 3000 mm lead with Euro plug
- sec.: 340 mm lead with 6-way distributor 4-pole

Art.-Nr. Art. No.	Ausführung Type	Gewicht/g Weight/g
538 173 04	CV1250 (12V, 50W)	480
538 171 15	CV2475 (24V, 75W)	480

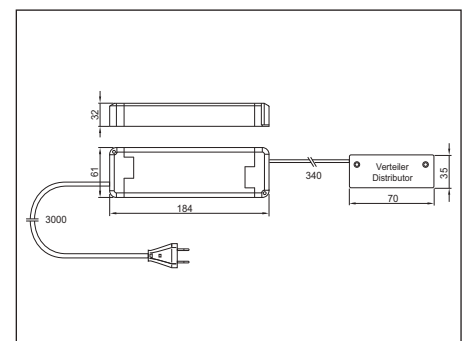

RGB A			RGB B		RGB C		RGB D		
<p>Zuleitung 6-fach Verteiler RGB max. 6A</p> <ul style="list-style-type: none"> • 155 mm Flachbandleitung – mit Ministecker oder – mit verzinnten Enden • Ministecker und Minibuchsen in pink <p>Supply lead 6-way distributor RGB 6A max.</p> <ul style="list-style-type: none"> • 155mm flat ribbon lead – with mini male plug or – with tinned ends • pink plug and sockets 			<p>Anschlussleitung RGB max. 6A</p> <ul style="list-style-type: none"> • Ministecker oder Minibuchse mit verzinnten Enden • Flachbandleitung • Stecker/Buchse in pink <p>Supply lead RGB 6A max.</p> <ul style="list-style-type: none"> • mini male plug or mini female socket resp. tinned ends with flat ribbon lead • pink plug/female socket 				<p>Verlängerungsleitung RGB max. 6A</p> <ul style="list-style-type: none"> • Ministecker/Minibuchse mit Flachbandleitung • Stecker und Buchse in pink <p>Extension lead RGB 6A max.</p> <ul style="list-style-type: none"> • mini male plug resp. mini female socket with flat ribbon lead • pink plug and socket 		
Art.-Nr. Art. No.	Ausführung Type	Gewicht/g Weight/g	Art.-Nr. Art. No.	Ausführung Type	Länge/mm Length/mm	Gewicht/g Weight/g	Art.-Nr. Art. No.	Länge/mm Length/mm	Gewicht/g Weight/g
539 233 01	Ministecker mini male plug	48	539 231 01	Ministecker	500	15	539 230 01	1000	45
			539 232 01	Minibuchse	500	18	539 230 02	2000	62

Installationsmöglichkeiten Installation options

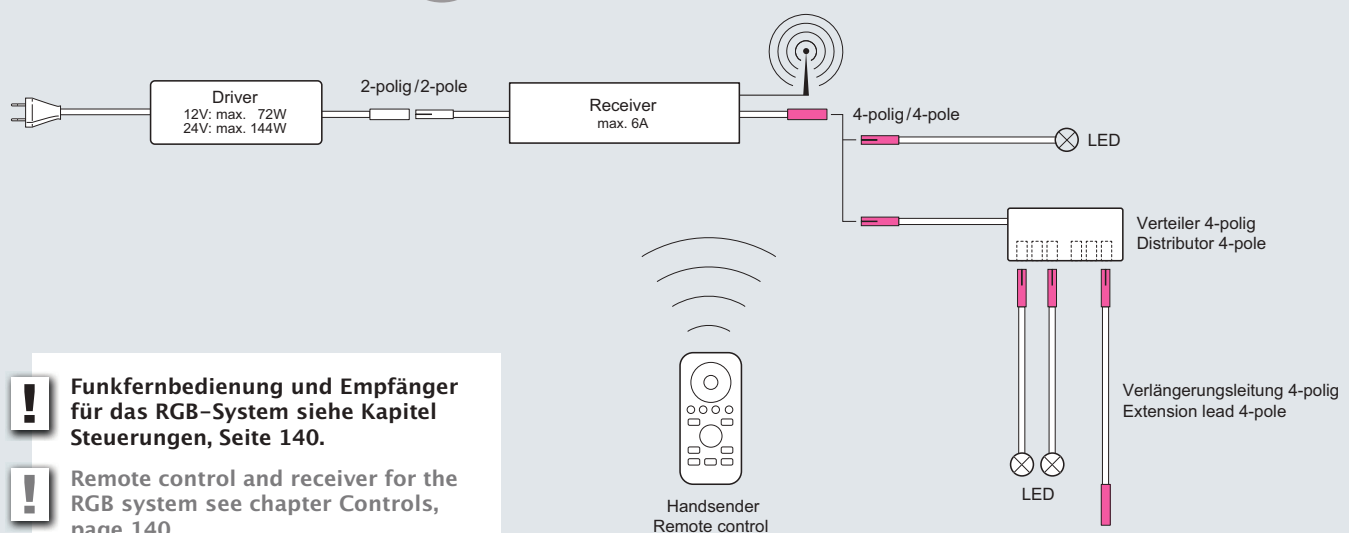

! Funkfernbedienung und Empfänger für das RGB-System siehe Kapitel Steuerungen, Seite 140.

! Remote control and receiver for the RGB system see chapter Controls, page 140.

ESP - LED-Stecksystem LED connector system

Abmessungen ESP
Dimensions ESP

2-polig · 3A · Schutzklasse II · 2x0,34mm²
2-pole · 3A · protection class II · 2x 0,34mm²

Stecker
Male plug

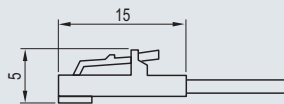

Buchse
Female socket

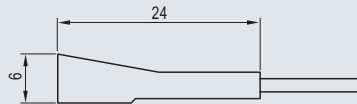

6-fach Verteiler seriell
6-way distributor serial

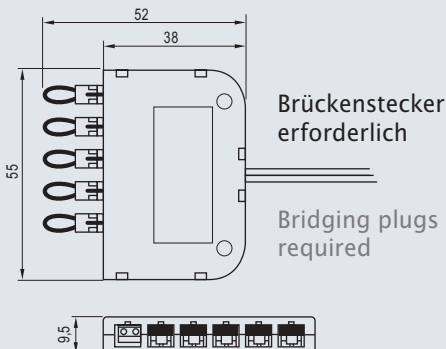

6-fach Verteiler parallel
6-way distributor parallel

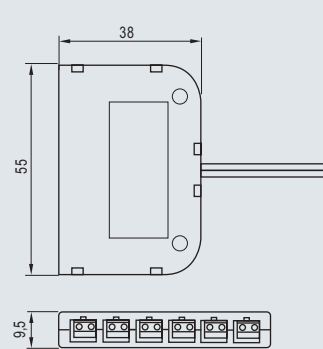

LED-Stecksystem zum Anschluss von Leuchten, die im Niedervoltbereich (Sicherheitskleinspannung) betrieben werden.

- Konstantstrom
- Konstantspannung

LED connector system for luminaires operated in low-voltage range (safety extra-low voltage).

- constant current
- constant voltage

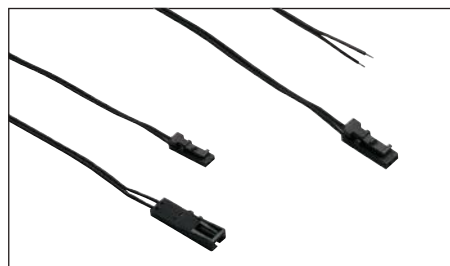

A

Verlängerungsleitung

- ESP-Stecker/ESP-Buchse

Extension lead

- ESP male plug/ESP female socket

Anschlussleitung

- ESP-Stecker/verzinnte Enden

Supply lead

- ESP male plug/tinned ends

Art.-Nr. Art. No.	Farbe Colour	Länge/mm Length/mm	Gewicht/g Weight/g
----------------------	-----------------	-----------------------	-----------------------

Verlängerungsleitung		Extension lead	
524 796 02	schwarz black	1000	10
524 796 03	schwarz black	2000	20

Anschlussleitung		Supply lead	
524 399 13	schwarz black	1000	10
524 399 16	schwarz black	1920	20

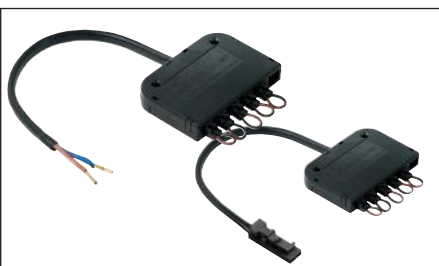

B

Serieller 6-fach Verteiler

- zum Anschluss von bis zu 6 CC LED-Leuchten
- ESP-Verteiler seriell mit 5 Brückensteckern für leere Steckplätze
- mit ESP Stecker oder Aderendhülsen

Serial 6-way distributor

- for connection of up to 6 CC LED lights
- serial ESP distributor with 5 bridging plugs for empty slots
- with ESP plug or bare ends

Art.-Nr. Art. No.	Farbe Colour	Ausführung/mm Type/mm	Gewicht/g Weight/g
----------------------	-----------------	--------------------------	-----------------------

524 770 01	schwarz black	155mm AEH	24
524 770 51	schwarz black	155mm ESP	23
524 770 52	schwarz black	2000mm ESP	33



C

Paralleler 6-fach Verteiler

- zum Anschluss von bis zu von bis zu 6 CV-LED-Leuchten

Parallel 6-way distributor

- for connection of up to 6 CV LED lights

Art.-Nr. Art. No.	Farbe Colour	Ausführung/mm Type/mm	Gewicht/g Weight/g
----------------------	-----------------	--------------------------	-----------------------

524 771 05	schwarz black	155 AEH	24
524 771 51	schwarz black	155 verz. Enden	24

2-polig · 2,5A · Schutzklasse II 2-pole · 2,5A · protection class II



A

Adapter

- für Lichtbandmontage

Adapter

- for continuous row mounting

Art.-Nr. Art. No.	Farbe Colour	Länge/mm Length/mm	Gewicht/g Weight/g
520 618 01	weiß white		5



B

Verlängerungsleitung

- Buchse C7/Stecker C8

Extension lead

- female socket C7/male plug C8

Art.-Nr. Art. No.	Farbe Colour	Länge/mm Length/mm	Gewicht/g Weight/g
512 575 11	weiß white	300	25
520 772 03	weiß white	1000	54
520 772 04	weiß white	1500	74



C

Zuleitung

- Buchse C7/Euroflachstecker

Supply lead

- Female socket C7/Euro plug

Art.-Nr. Art. No.	Farbe Colour	Länge/mm Length/mm	Gewicht/g Weight/g
520 689 01	weiß white	2000	83



D

Zuleitung

- Winkelbuchse C7/Euroflachstecker

Supply lead

- female angled socket C7/Euro plug

Art.-Nr. Art. No.	Farbe Colour	Länge/mm Length/mm	Gewicht/g Weight/g
520 944 01	weiß white	2000	85



E

Zuleitung

- Winkelbuchse C7/Aderendhülsen

Supply lead

- female angled socket C7/
bare ends

Art.-Nr. Art. No.	Farbe Colour	Länge/mm Length/mm	Gewicht/g Weight/g
520 950 01	weiß white	2000	86



F

Adapterleitung C7/C8 → D8

- Buchse C7/Ministecker

Adapter lead C7/C8 → D8

- female socket C7/mini male plug

Art.-Nr. Art. No.	Farbe Colour	Länge/mm Length/mm	Gewicht/g Weight/g
531 113 21	weiß white	2000	70

Artikelnummernindex Index of article numbers

Art-Nr. Art No.	Seite Page	Art-Nr. Art No.	Seite Page	Art-Nr. Art No.	Seite Page	Art-Nr. Art No.	Seite Page	Art-Nr. Art No.	Seite Page
500 000 01	29	529 310 02	160	531 111 12	170	538 087 61	21	538 446 04	41
500 000 02	31	529 310 05	160	531 111 13	170	538 087 62	21	538 446 11	41
500 000 03	33	529 310 22	160	531 111 17	170	538 087 63	21	538 446 12	41
500 000 06	61	529 470 01	158	531 111 24	170	538 087 64	21	538 446 13	41
500 000 07	51	529 470 03	158	531 112 01	171	538 095 01	127	538 446 14	41
500 000 09	57	529 581 02	158	531 113 21	172	538 096 01	127	538 446 31	41
500 000 11	55	529 581 03	158	531 113 42	171	538 115 02	136	538 446 32	41
500 000 12	69	529 581 04	158	531 113 51	171	538 115 06	136	538 446 33	41
500 000 13	67	529 685 01	172	531 114 03	161	538 166 01	126	538 446 34	41
500 000 14	63	529 685 02	172	531 114 06	171	538 167 01	126	538 591 ..*	74
500 000 15	71	529 686 01	183	531 115 01	170	538 171 02	136	538 592 ..*	74
510 849 01	181	529 686 99	183	531 115 21	170	538 171 11	136	538 597 ..*	74
510 849 02	181	529 753 01	172	531 115 45	170	538 171 15	188	538 598 ..*	74
510 849 11	181	529 753 02	172	531 115 50	170	538 173 04	188	538 599 ..*	74
510 849 22	181	529 753 12	180	531 115 57	172	538 178 51	19	538 600 ..*	74
511 377 05	161	529 753 22	177	531 115 69	172	538 178 52	19	538 674 18	87
511 377 06	161	529 753 32	183	531 115 87	162	538 178 53	19	538 674 19	87
511 377 07	161	529 840 01	183	531 116 01	170	538 178 54	19	538 674 23	87
512 575 11	191	529 840 03	183	531 116 21	170	538 178 61	19	538 674 32	87
520 618 01	191	529 840 05	183	531 118 01	170	538 178 62	19	538 674 33	87
520 689 01	191	529 840 07	183	531 118 02	170	538 178 63	19	538 674 34	87
520 772 03	191	529 841 01	182	531 195 02	159	538 178 64	19	538 674 35	87
520 772 04	191	529 841 02	182	531 195 04	159	538 179 51	19	538 675 01	89
520 944 01	191	529 841 03	182	531 195 05	159	538 179 52	19	538 675 02	89
520 950 01	191	529 841 04	182	531 195 22	159	538 179 53	19	538 675 20	91
522 090 01	181	529 841 05	182	531 196 02	159	538 179 54	19	538 675 21	91
522 090 02	181	529 841 06	182	531 196 04	159	538 179 61	19	538 731 ..*	76
523 985 01	158	529 842 01	183	531 196 05	159	538 179 62	19	538 733 88	93
524 350 01	175	529 842 02	183	531 196 22	159	538 179 63	19	538 737 88	93
524 350 02	175	529 842 03	182	531 301 03	173	538 179 64	19	538 738 ..*	80
524 350 03	175	529 842 04	183	531 301 04	173	538 233 11	23	538 739 ..*	80
524 350 04	175	529 842 05	183	531 301 05	173	538 233 12	23	538 748 ..*	80
524 350 07	175	529 842 06	183	531 414 01	170	538 233 13	23	538 749 ..*	76
524 354 01	175	529 842 07	182	531 479 01	170	538 233 14	23	538 752 88	93
524 354 02	175	529 842 08	182	531 559 22	160	538 233 15	23	538 753 ..*	99
524 356 01	175	529 842 09	183	531 559 26	160	538 233 16	23	538 754 ..*	99
524 356 02	175	529 843 01	183	531 588 01	159	538 233 17	23	538 762 ..*	76
524 368 01	185	529 843 02	183	531 598 01	159	538 233 18	23	538 763 ..*	76
524 368 02	185	529 843 03	183	531 634 02	160	538 233 19	23	538 764 ..*	80
524 368 03	185	529 843 04	183	531 707 01	180	538 233 20	23	538 765 01	96
524 369 01	184	529 843 05	183	531 707 02	180	538 233 22	23	538 766 01	96
524 369 02	184	529 843 06	183	531 707 03	180	538 233 28	23	538 767 01	97
524 369 03	184	529 843 07	183	531 708 06	181	538 240 02	91	538 782 ..*	98
524 369 04	184	529 853 01	173	531 708 19	181	538 295 11	25	538 791 02	116
524 369 05	184	529 853 98	173	531 708 22	181	538 295 12	25	538 809 01	43
524 369 06	184	529 853 99	173	531 708 98	181	538 295 13	25	538 809 02	43
524 370 01	185	529 894 01	178	531 708 99	181	538 295 14	25	538 809 03	43
524 370 02	185	529 905 ..*	80	531 709 01	181	538 295 15	25	538 809 04	43
524 370 03	185	529 916 01	178	531 709 06	181	538 296 11	25	538 809 11	43
524 370 04	185	529 916 02	178	531 709 99	181	538 296 12	25	538 809 12	43
524 370 05	185	529 916 03	178	531 710 02	180	538 296 13	25	538 809 13	43
524 370 06	185	529 916 29	178	531 792 55	159	538 296 14	25	538 809 14	43
524 370 07	184	529 916 34	178	531 792 67	159	538 296 15	25	538 809 51	43
524 370 08	184	529 916 35	178	531 889 01	120	538 306 11	23	538 809 52	43
524 370 09	184	529 916 40	178	531 891 01	120	538 306 12	23	538 809 53	43
524 371 01	185	529 916 41	178	532 671 01	171	538 306 13	23	538 809 54	43
524 371 02	185	529 917 02	177	532 672 01	171	538 306 14	23	538 809 61	43
524 371 03	185	529 917 04	177	532 673 01	171	538 306 15	23	538 809 62	43
524 372 01	185	529 917 05	177	532 673 02	171	538 306 16	23	538 809 63	43
524 372 02	185	529 917 07	177	532 674 01	171	538 306 17	23	538 809 64	43
524 372 03	185	529 917 08	177	532 674 02	171	538 306 18	23	538 838 01	120
524 399 13	190	529 917 09	177	532 735 01	156	538 308 01	128	538 850 01	131
524 399 16	190	529 917 10	177	532 735 02	156	538 308 02	128	538 882 08	14
524 458 11	128	529 917 13	177	532 735 03	156	538 308 11	128	538 882 18	14
524 458 14	128	529 917 20	177	532 735 04	156	538 308 12	128	538 882 28	14
524 458 17	128	529 918 01	177	532 735 26	157	538 309 ..*	129	538 882 38	14
524 746 55	159	529 918 02	177	532 735 52	156	538 310 ..*	129	538 897 ..*	98
524 746 67	159	529 918 03	177	532 735 55	156	538 342 01	179	538 900 01	187
524 770 01	190	529 918 06	177	532 740 01	165	538 342 02	179	538 900 02	187
524 770 51	190	529 918 07	177	532 740 55	165	538 342 03	179	538 901 01	188
524 770 52	190	529 919 01	177	532 760 ..*	74	538 342 05	179	538 901 02	188
524 771 05	190	529 919 02	177	532 976 01	165	538 343 01	179	538 901 04	188
524 771 51	190	529 919 03	177	532 976 55	165	538 343 02	179	538 903 01	187
524 793 ..*	129	529 919 04	177	532 980 01	165	538 343 03	179	538 904 01	187
524 794 ..*	129	529 919 05	177	532 980 55	165	538 343 04	179	538 905 01	188
524 795 ..*	129	529 919 06	177	533 358 ..*	74	538 343 09	179	538 905 02	188
524 796 02	190	529 919 08	177	538 001 01	126	538 344 01	179	538 908 01	187
524 796 03	190	529 919 09	177	538 002 01	126	538 344 02	179	538 908 02	187
524 956 01	173	529 929 ..*	76	538 003 01	126	538 344 03	179	538 908 04	187
525 701 12	161	531 111 01	170	538 004 02	132	538 344 06	179	538 909 01	187
529 257 01	164	531 111 02	170	538 005 01	134	538 344 08	179	538 909 02	187
529 257 55	164	531 111 03	170	538 087 51	21	538 355 01	97	538 910 01	187
529 280 05	155	531 111 05	170	538 087 52	21	538 446 01	41	538 956 88	95
529 303 03	74	531 111 06	170	538 087 53	21	538 446 02	41	538 962 01	147
529 310 01	160	531 111 07	170	538 087 54	21	538 446 03	41	538 982 02	45